

1 di 4
Disegni Scala 1/1

rinforzo vetronite trasto

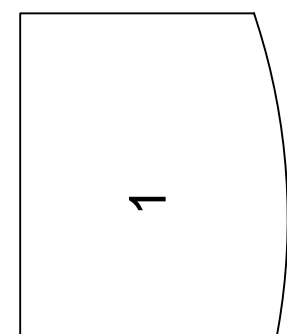
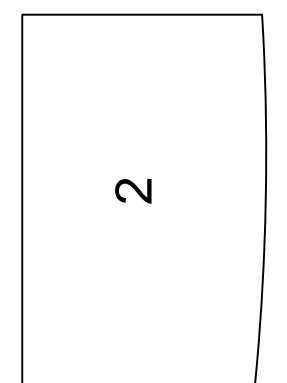
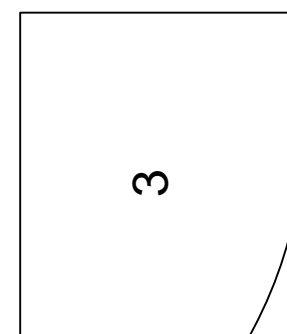
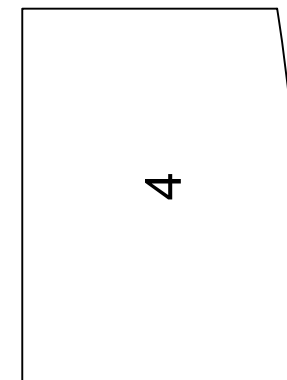
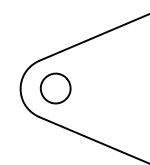
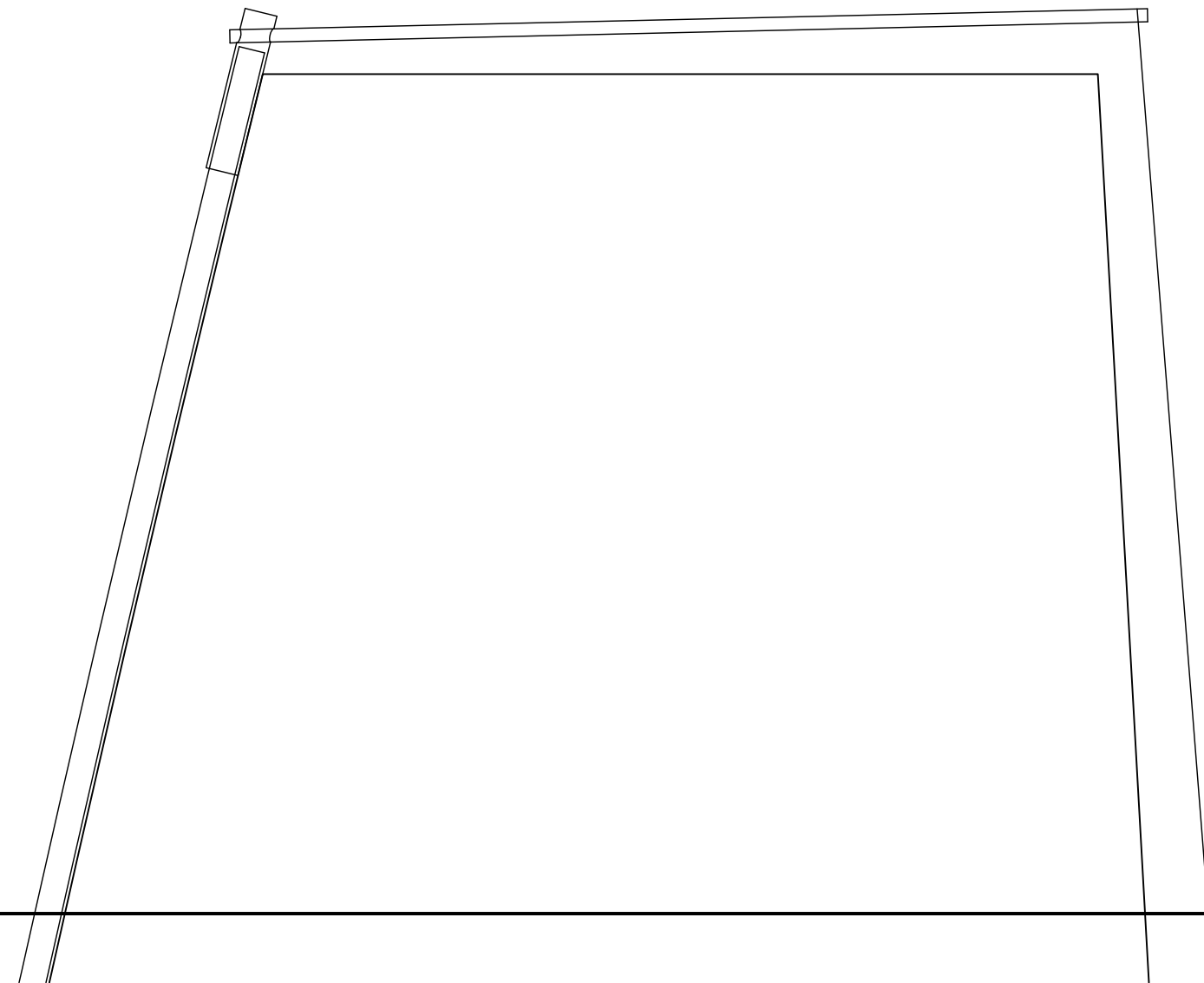
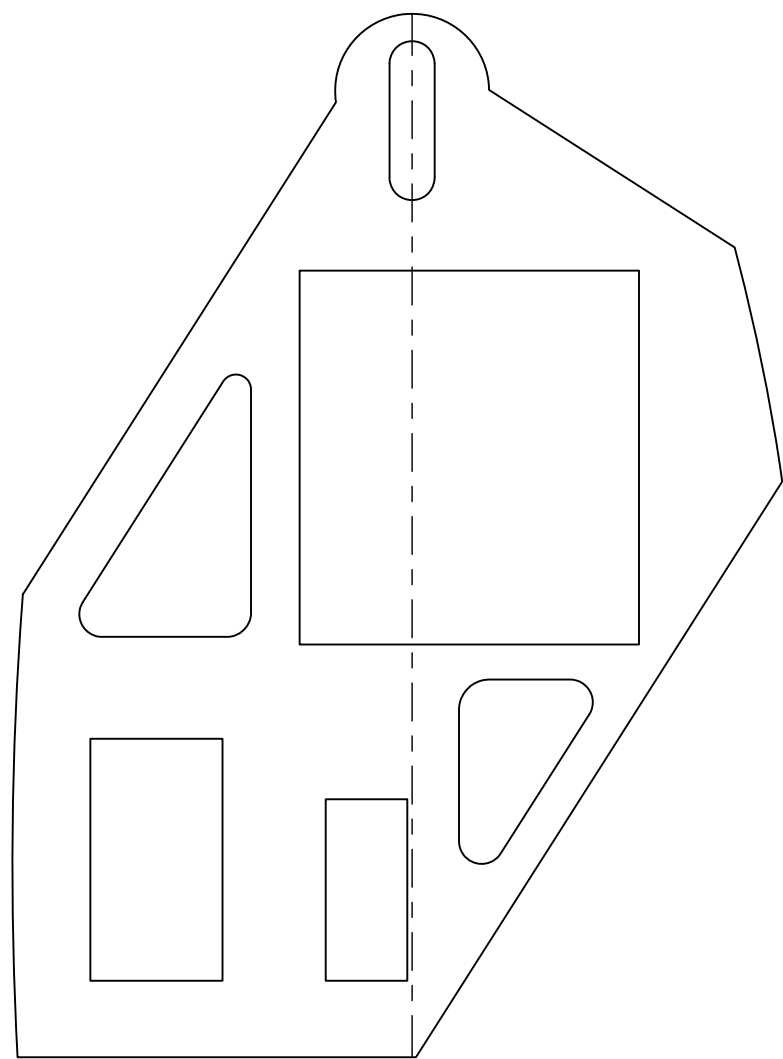
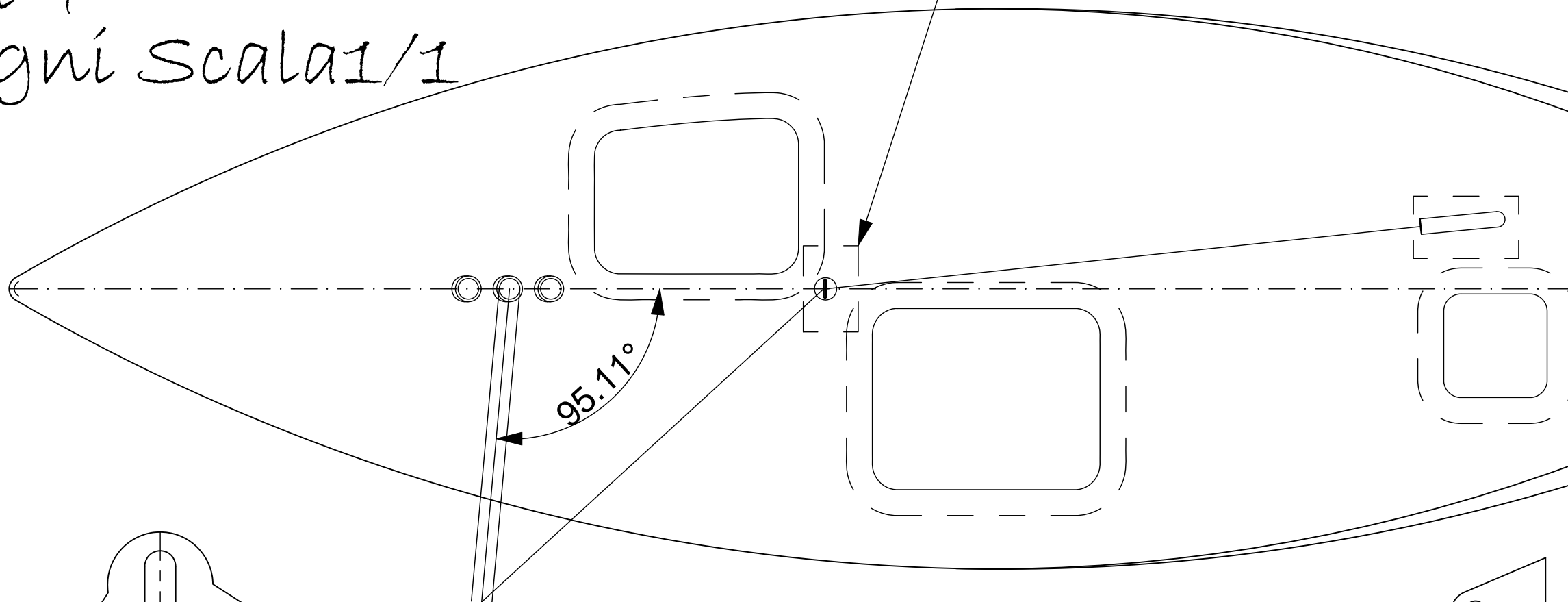

110

100

90

2 di 4
Disegni Scala 1/1

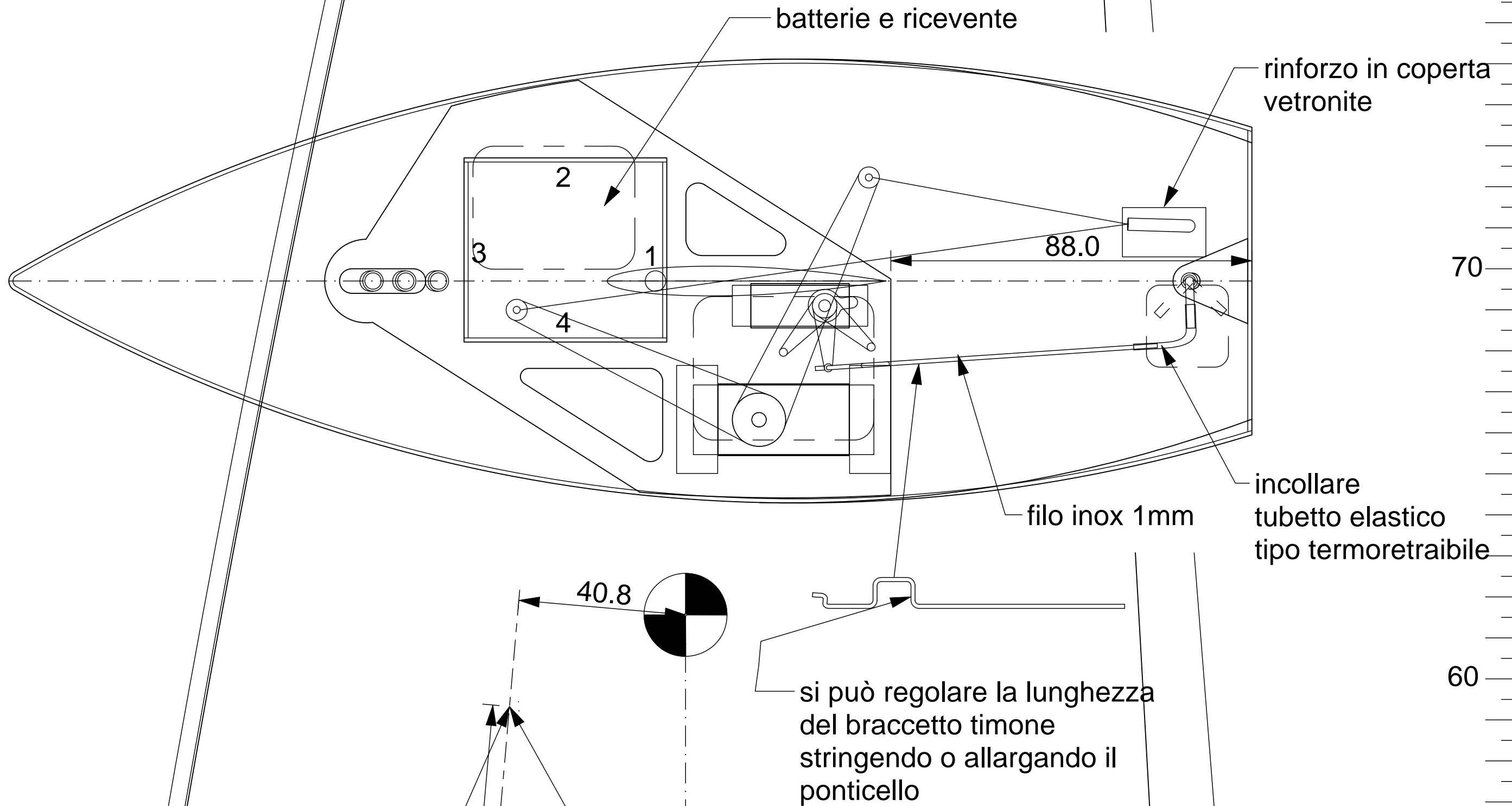

3 di 4
Disegni Scala 1/1

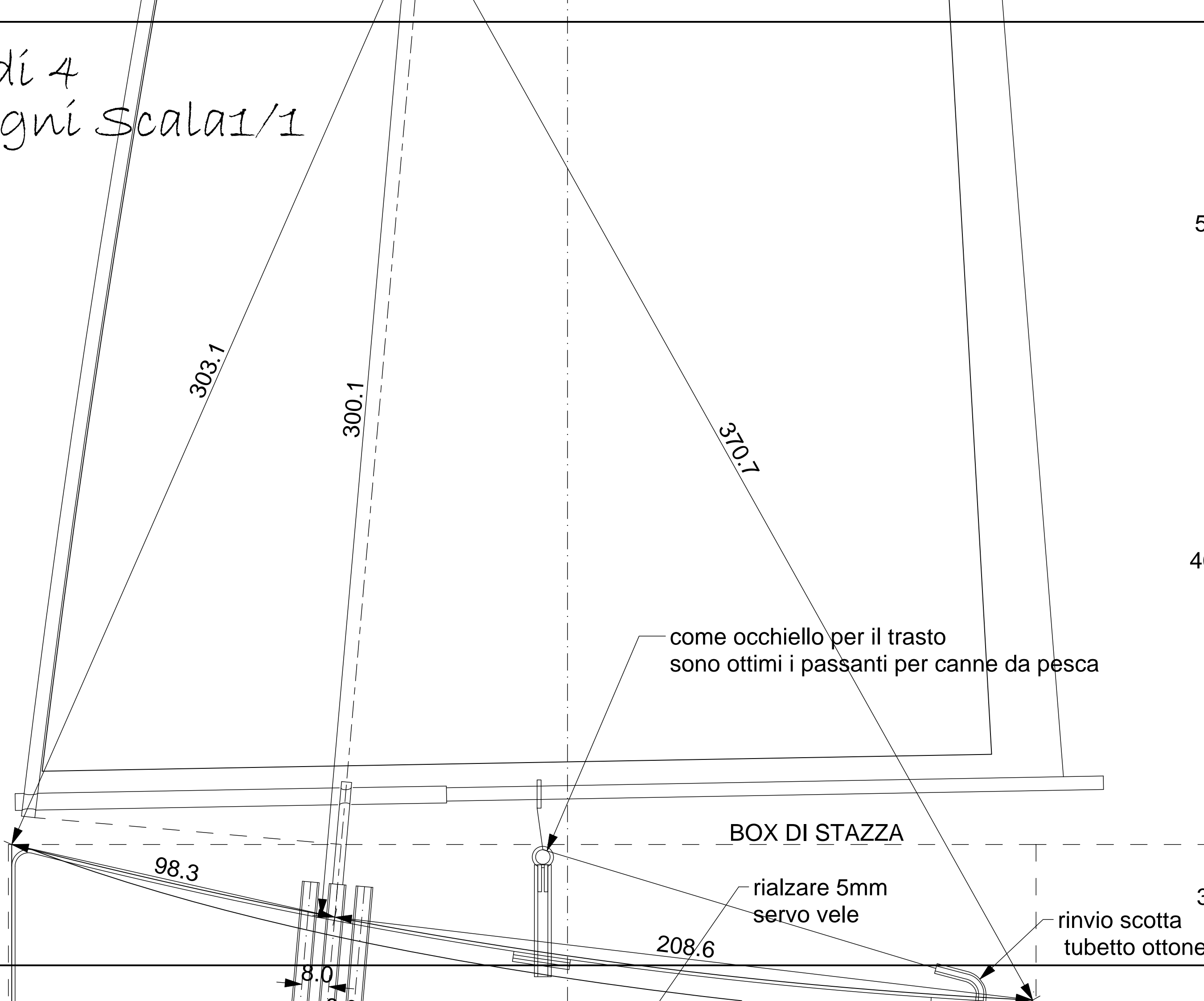

50

40

30

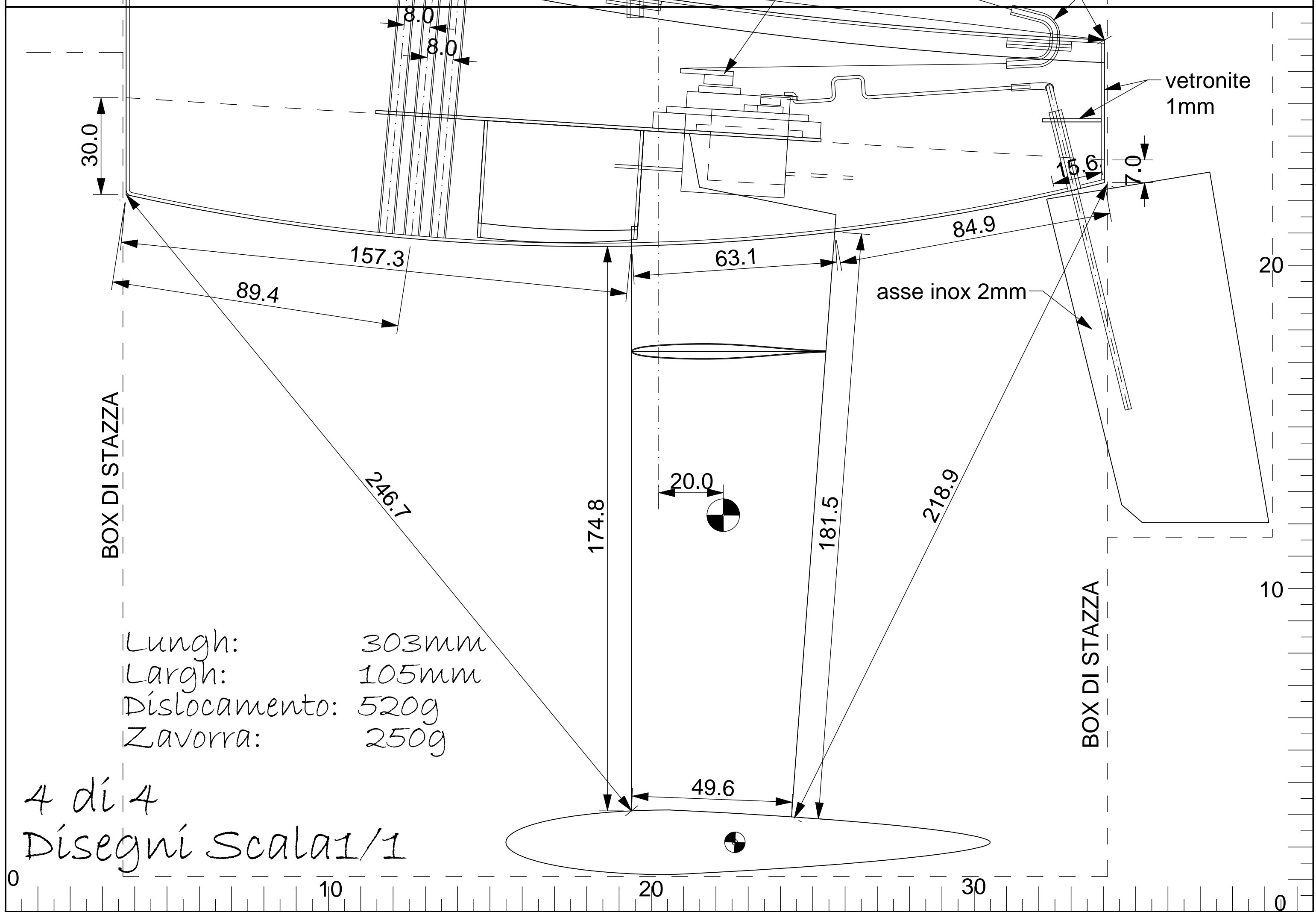

Lungh: 303mm
 Largh: 105mm
 Dislocamento: 520g
 Zavorra: 250g

4 di 4
 Disegni Scala 1/1

