



Instruction Manual book

MINIMOA

95% PRE BUILT
ARF
ALMOST READY TO FLY

GLIDER



ALL Balsa- PLY WOOD CONSTRUCTION.
COVERED WITH ORACOVER®

ITEM CODE: BH88.

95% ALMOST READY TO FLY

SPECIFICATION

<input type="checkbox"/> Wingspan :	3,400 mm	133.86 in.
<input type="checkbox"/> Length :	1,450 mm	57.09 in.
<input type="checkbox"/> Weight :	3,0 kg	6.6 Lbs.
<input type="checkbox"/> Radio :	05 channels.	
<input type="checkbox"/> Servo :	05 servos	HS485 HB (4,8 kg/cm) - BMS 631MG (5 kg/cm)
<input type="checkbox"/> Mini servo :	02 Servos	HS85 BB MG (3,0 kg/cm) - BMS 380MG (3,6 kg/cm)

Made in Vietnam.

This instruction manual is designed to help you build a great flying aeroplane. Please read this manual thoroughly before starting assembly of your MINIMOA. Use the parts listing below to identify all parts.

WARNING.

Please be aware that this aeroplane is not a toy and if assembled or used incorrectly it is capable of causing injury to people or property. WHEN YOU FLY THIS AEROPLANE YOU ASSUME ALL RISK & RESPONSIBILITY.

If you are inexperienced with basic R/C flight we strongly recommend you contact your R/C supplier and join your local R/C Model Flying Club. R/C Model Flying Clubs offer a variety of training procedures designed to help the new pilot on his way to successful R/C flight. They will also be able to advise on any insurance and safety regulations that may apply.

TOOLS & SUPPLIES NEEDED.

- Thick cyanoacrylate glue.
- 30 minute epoxy.
- 5 minute epoxy.
- Hand or electric drill.
- Assorted drill bits.
- Modelling knife.
- Straight edge ruler.
- 2mm ball driver.
- Phillips head screwdriver.
- 220 grit sandpaper.
- 90° square or builder's triangle.
- Wire cutters.
- Masking tape & T-pins.
- Thread-lock.
- Paper towels.

Some more parts.

HARDWARE PACK

COWLING.
Landing gear.....

SUGGESTION.

To avoid scratching your new airplane, do not unwrap the pieces until they are needed for assembly. Cover your workbench with an old towel or brown paper, both to protect the aircraft and to protect the table. Keep a couple of jars or bowls handy to hold the small parts after you open the bag.

PARTS LISTING.

FUSELAGE ASSEMBLY

- (1) Fuselage.

WING ASSEMBLY

- (1) Right wing half with pre-installed aileron.
- (1) Left wing half with pre-installed aileron.

Tail section assembly

- (1) Vertical stabilizer with pre-installed rudder.
- (1) Horizontal stabilizer with pre-installed elevator halves.

NOTE.

Please trial fit all the parts. Make sure you have the correct parts and that they fit and are aligned properly before gluing! This will assure proper assembly. **MINIMOA** ARF is hand made from natural materials, every plane is unique and minor adjustments may have to be made. However, you should find the fit superior and assembly simple.

The painted and plastic parts used in this kit are fuel proof. However, they are not tolerant of many harsh chemicals including the following: paint thinner, C/A glue accelerator, C/A glue debonder and acetone. Do not let these chemicals come in contact with the colors on the covering and the plastic parts.

SAFETY PRECAUTION.

- + This is not a toy
- + Be sure that no other flyers are using your radio frequency.
- + Do not smoke near fuel
- + Store fuel in a cool, dry place, away from children and pets.
- + Wear safety glasses.
- + The glow plug clip must be securely attached to the glow plug.

- + Do not flip the propeller with your fingers.
- + Keep loose clothing and wires away from the propeller.
- + Do not start the engine if people are near. Do not stand in line with the side of the propeller.
- + Make engine adjustments from behind the propeller only. Do not reach around the spinning propeller.

REPLACEMENT LARGE PARTS

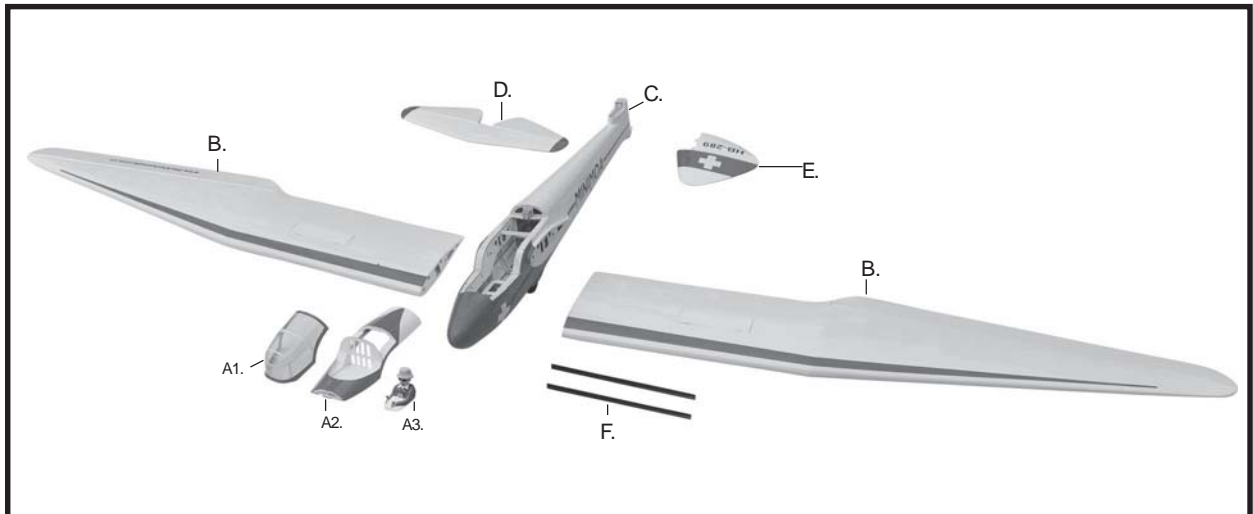

- A1. Canopy.
- A2. Pilot window.
- A3. Pilot.
- B. Wing panel.
- C. Fuselage.
- D. Horizon stabilizer.
- E. Vertical stabilizer.
- F. Carbon tube.

REPLACEMENT SMALL PARTS

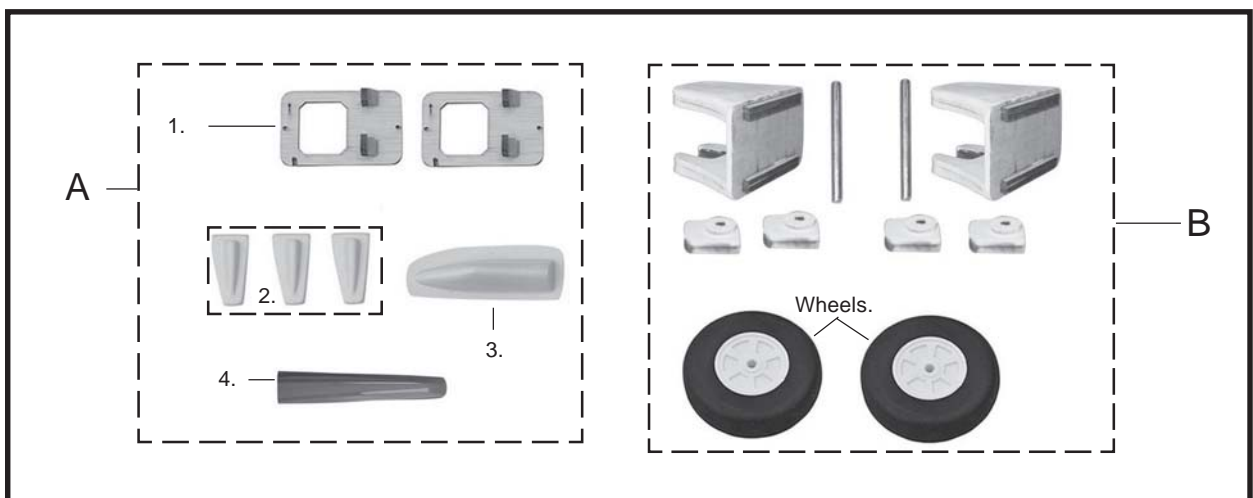

A. Accessories of airplane

- 1. Servo trays.
- 2. Plastic parts for elevator pushrod and rudder pushrod.
- 3. Plastic for tail fuselage.
- 4. Plastic parts for fuselage

B. Accessories of wood box.

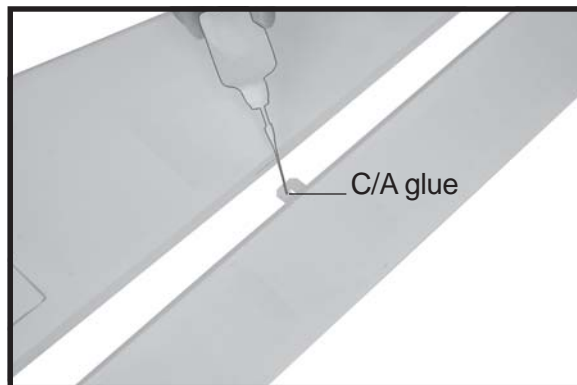

I. AILERON.

1. INSTALLING THE AILERON SERVOS.

- 1) Install the rubber grommets and brass eyelets onto the aileron servos.

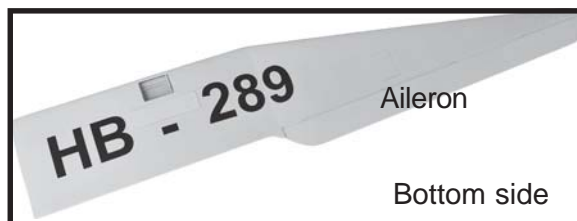
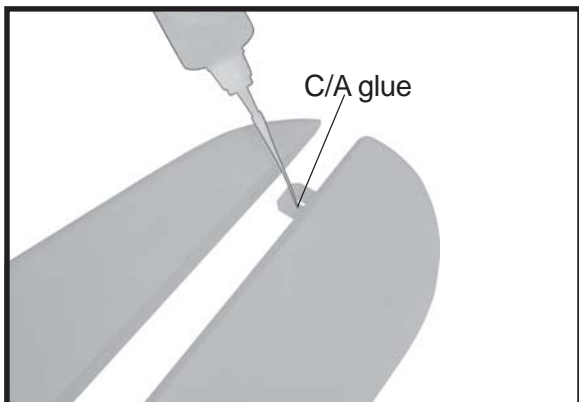
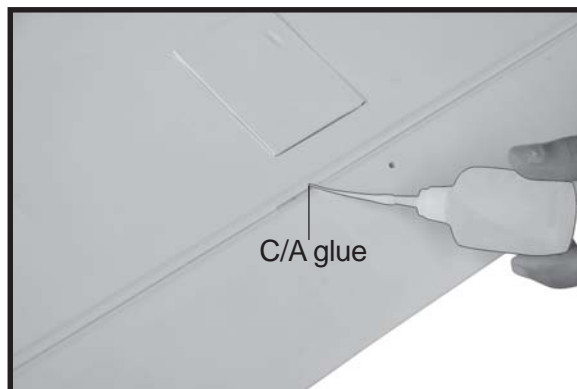
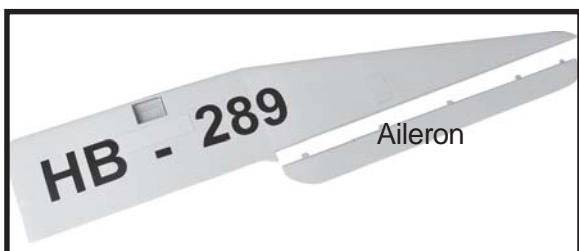
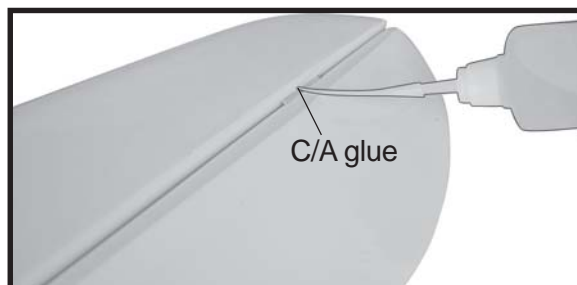
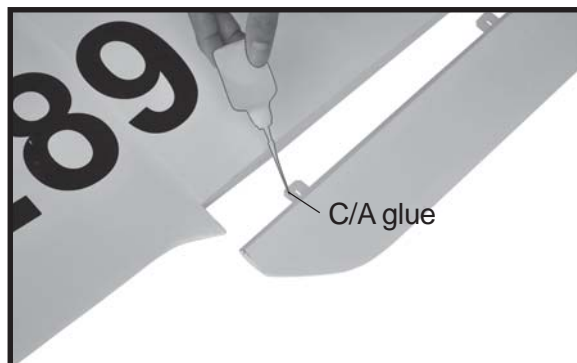

- 2) Using a modeling knife, remove the covering at position show below.

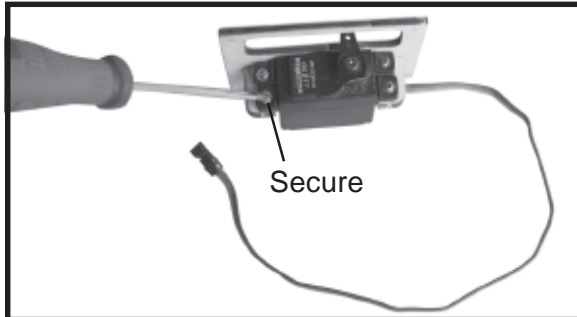
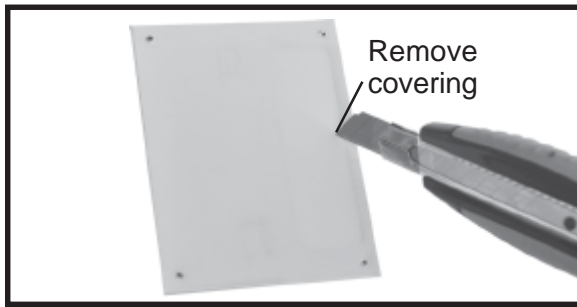

□ 3) Using the thread as a guide and using masking tape, tape the servo lead to the end of the thread: carefully pull the thread out. When you have pulled the servo lead out, remove the masking tape and the servo lead from the thread.



□ 4) Drill 1,6mm pilot holes through the block of wood for each of the four mounting screws provided with the servo.

□ 5. Instal servo tray with aileron servo into the wing as same as picture below.

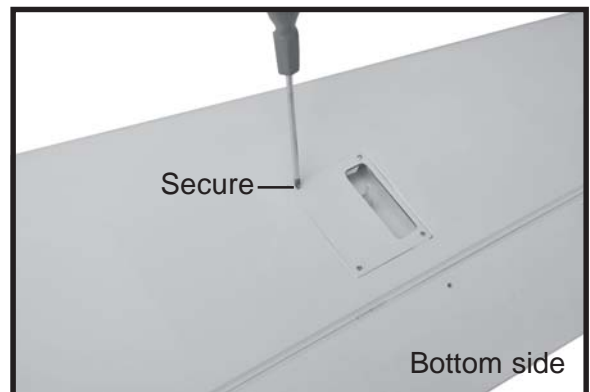
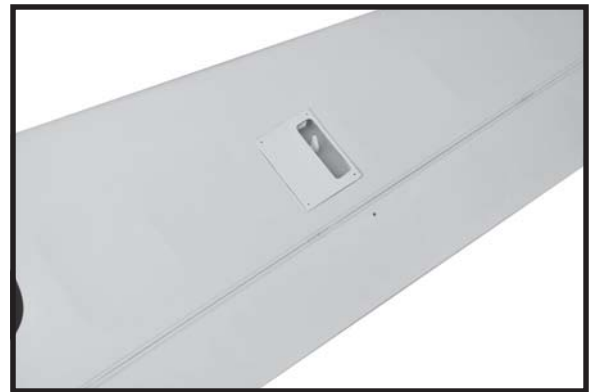
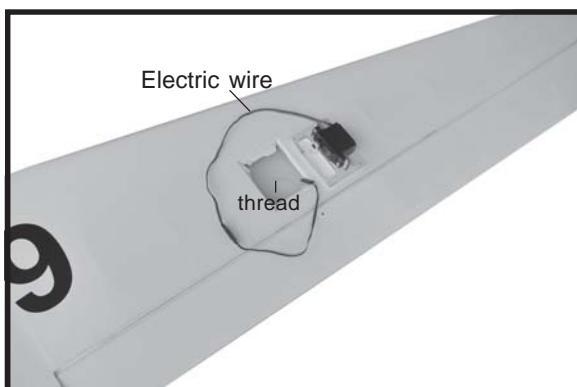

2.INSTALLING THE AILERON CONTROL HORN

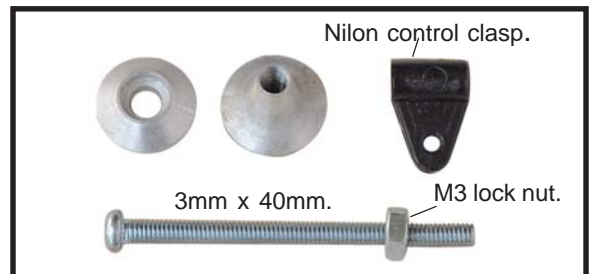

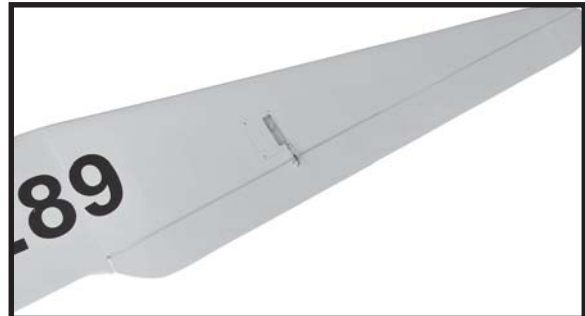
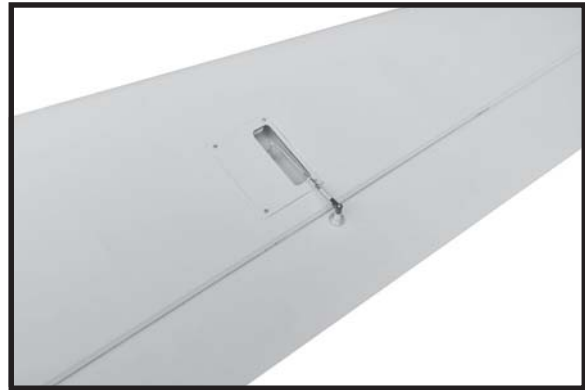
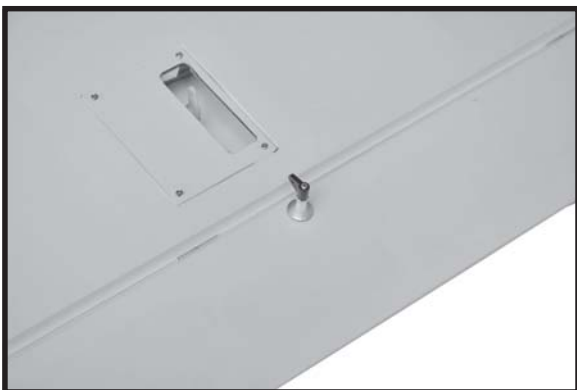
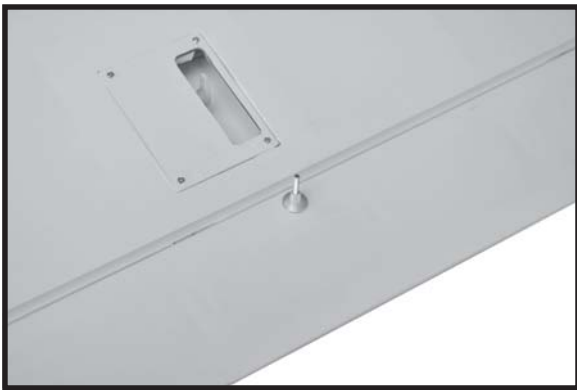

Repeat the procedure for the other wing half.

3.INSTALLING THE AILERON LINKAGES.

Installing the aileron linkages as pictures below.

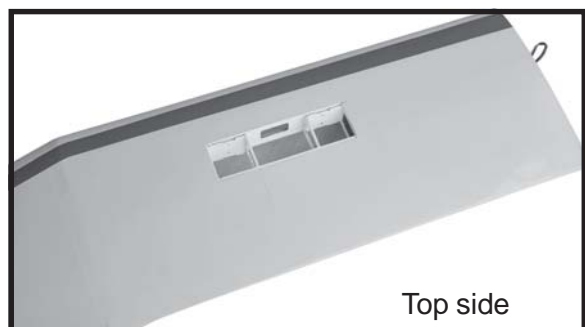
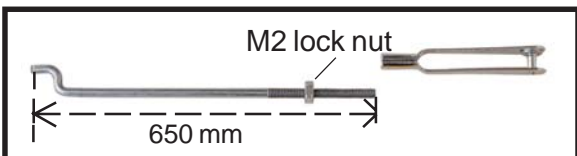

Top side

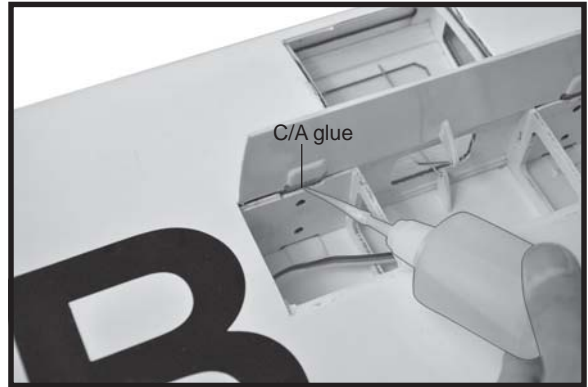
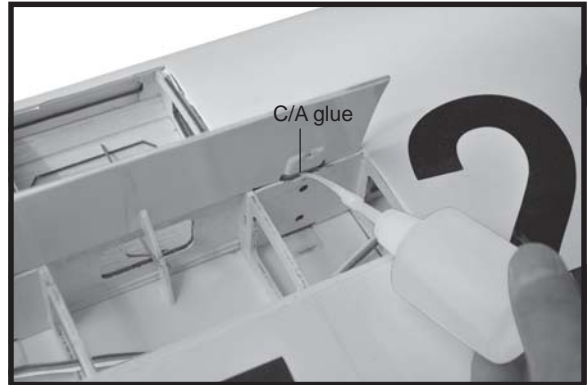
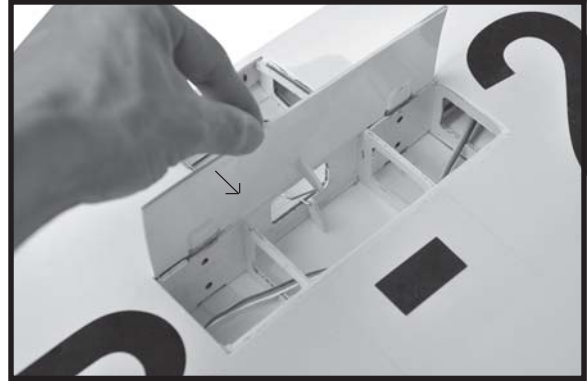
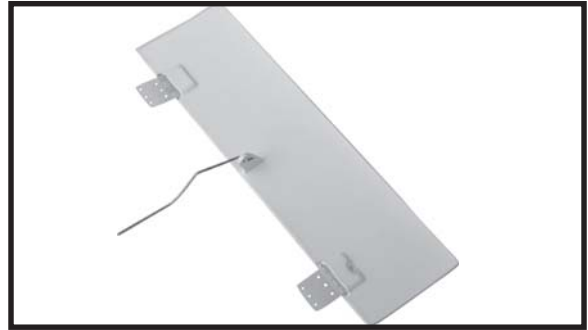
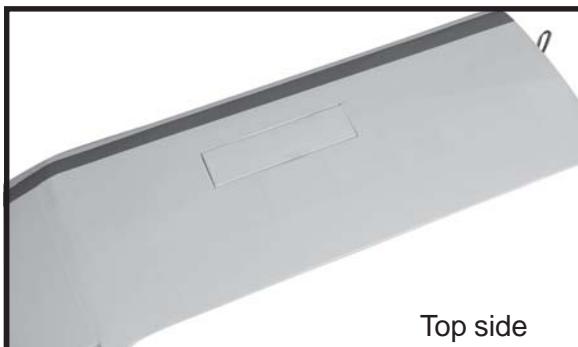
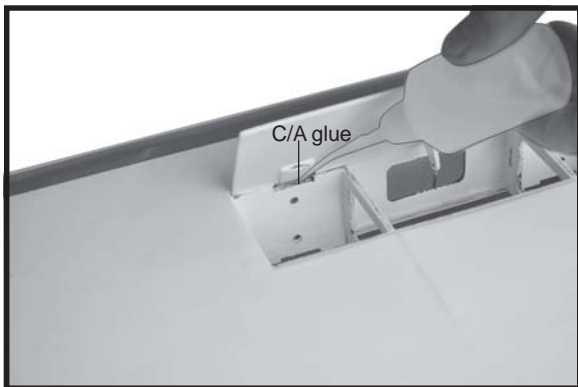
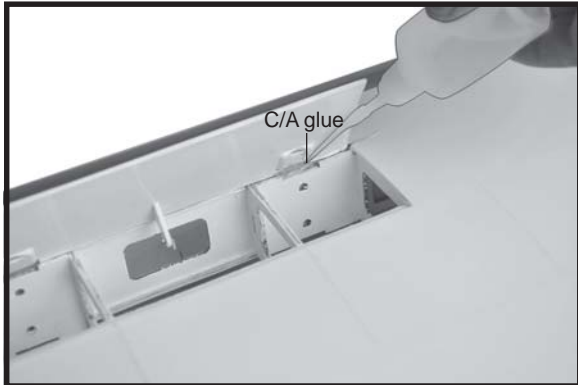
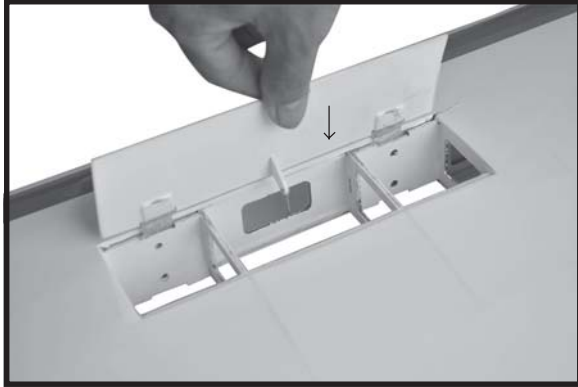
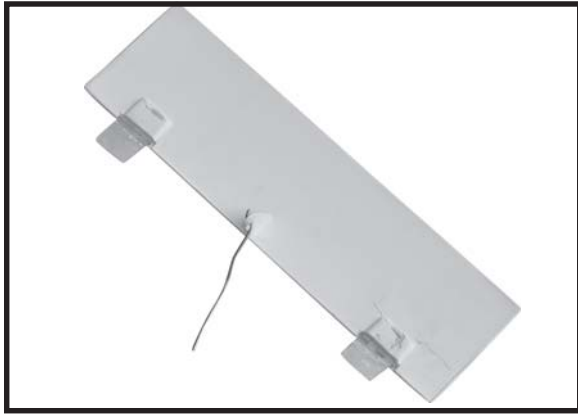

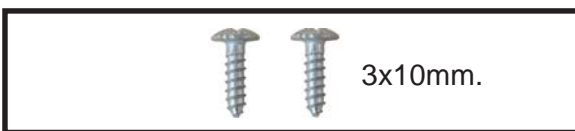
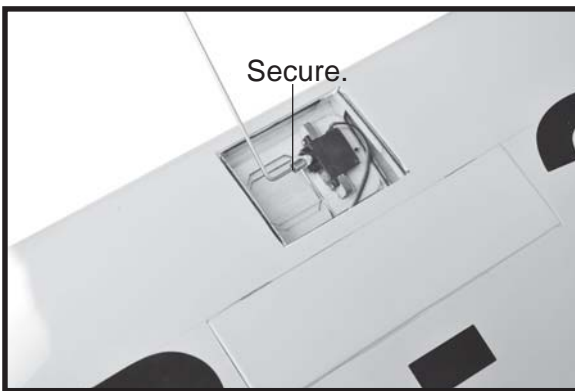
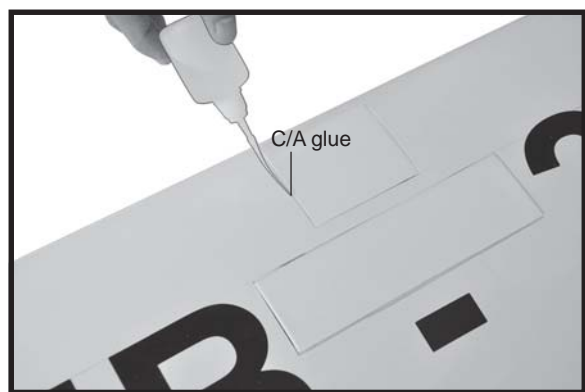
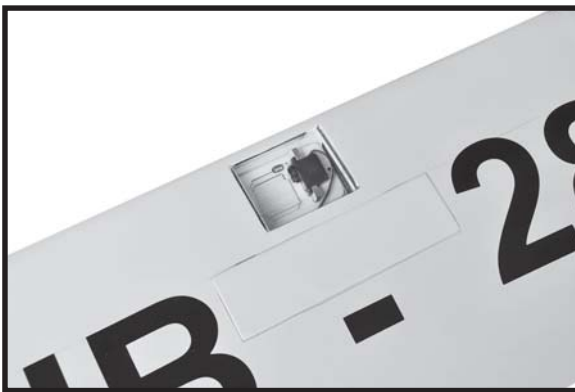
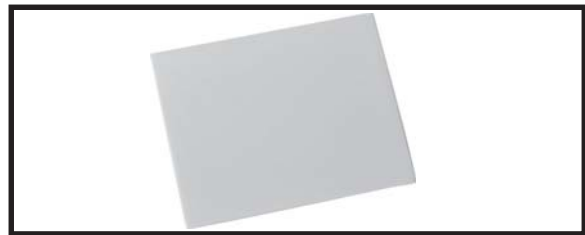
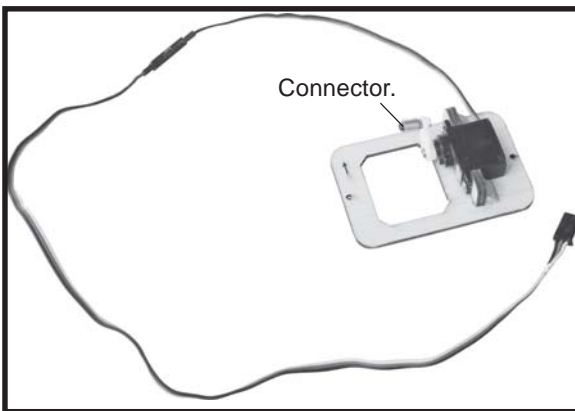
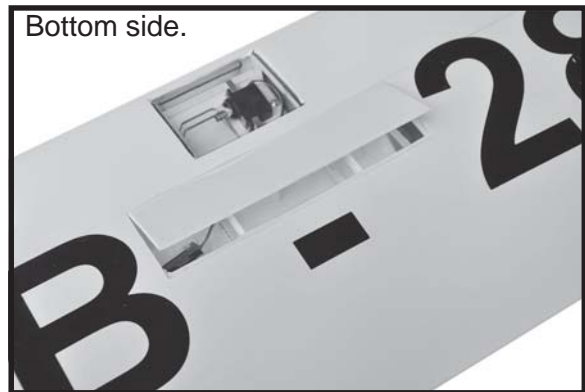
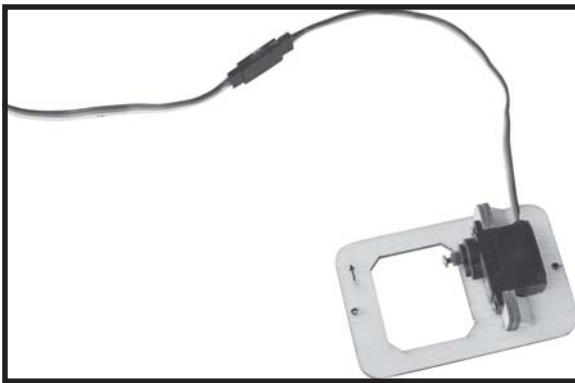

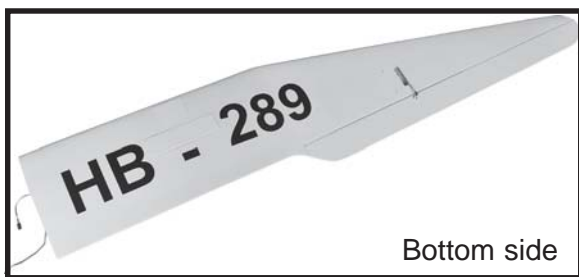

ELEVATOR INSTALLATION.

SERVO INSTALLATION.

- 1. Install the rubber grommets and brass collets into the elevator servo. Test fit the servo into the servo tray.
- 2. Mount the servo to the tray using the mounting screws provided with your radio system.

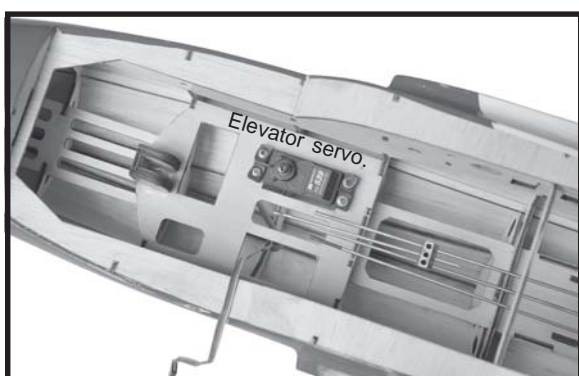
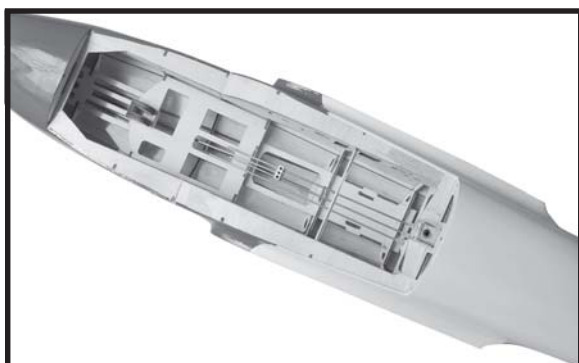

HORIZONTAL STABILIZER.

See pictures below:

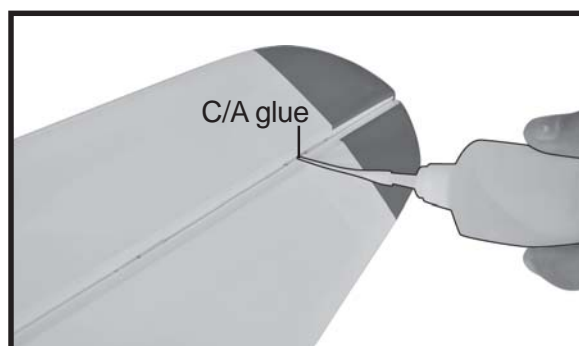
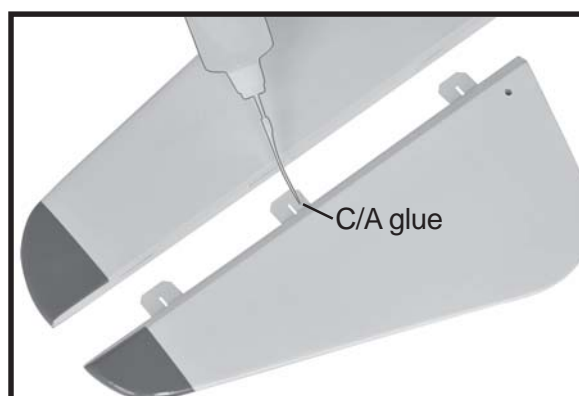
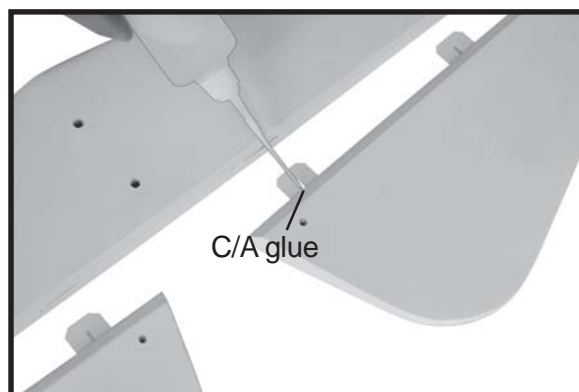
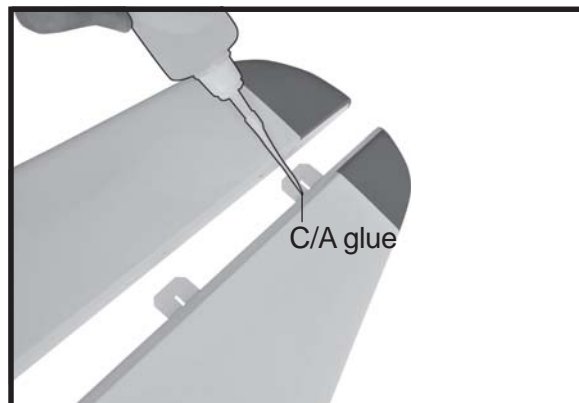
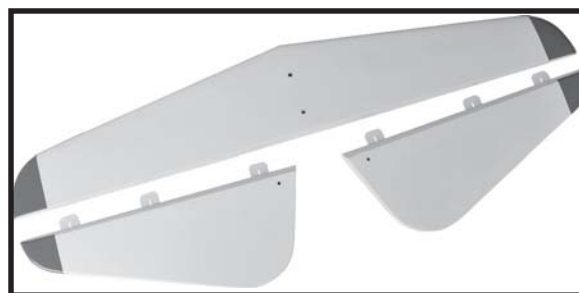

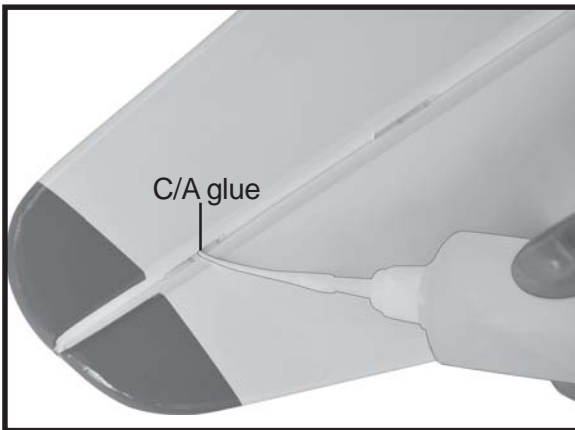
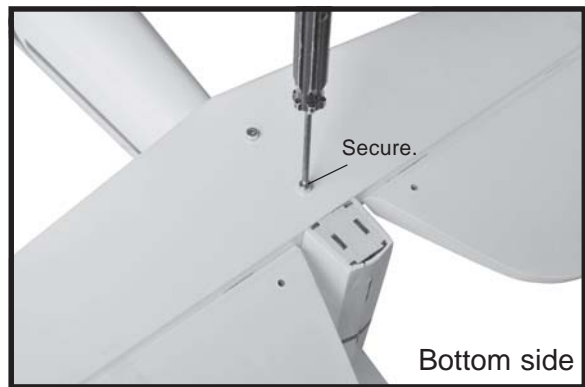
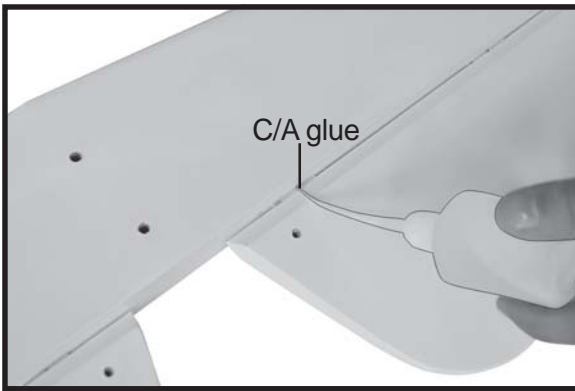

**ELEVATOR CONTROL HORN
PUSHROD INSTALLATION.**

Elevator control horn install as same as the way of aileron control horn. Please see pictures below.

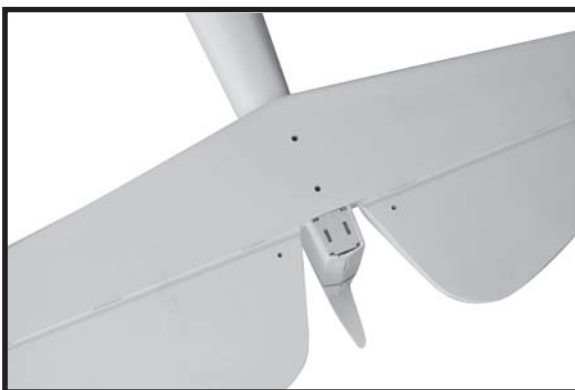
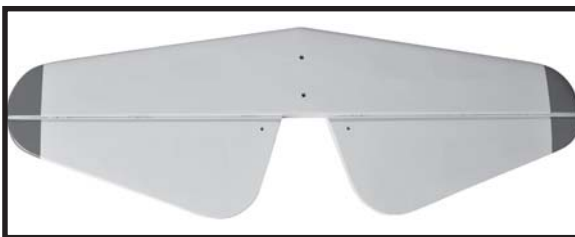
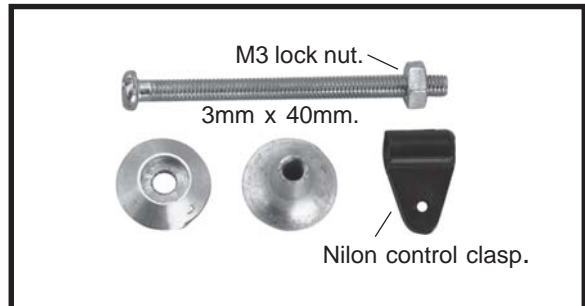



ELEVATOR PUSHROD INSTALLATION.

Elevator pushrod install as same as the way of aileron pushrod.

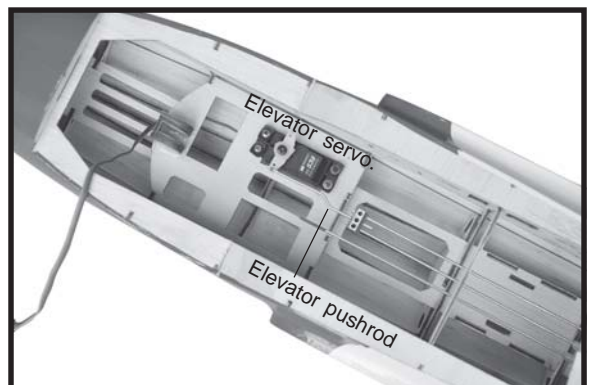
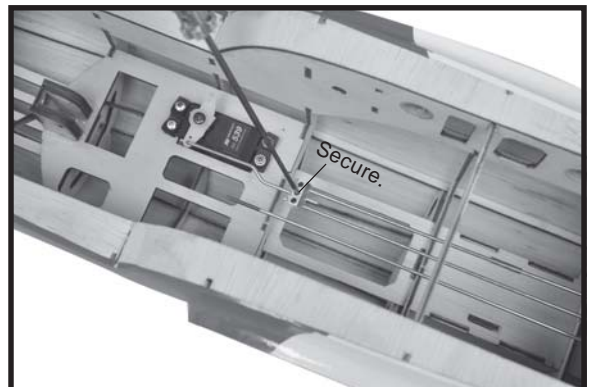
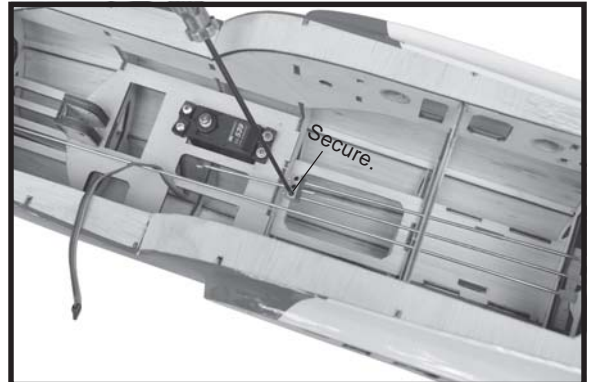
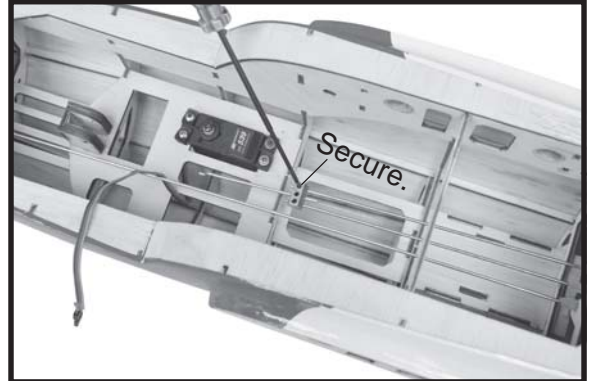
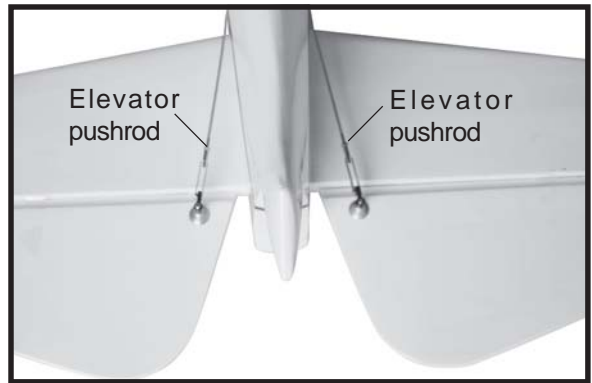

VERTICAL INSTALLATION.

Rudder servo install as same as method of elevator servo. See picture below:

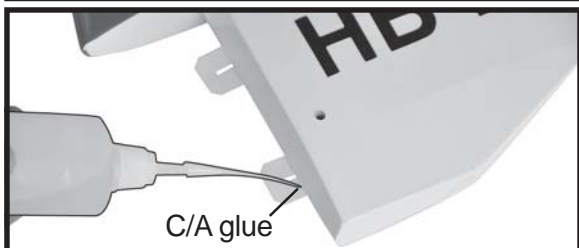
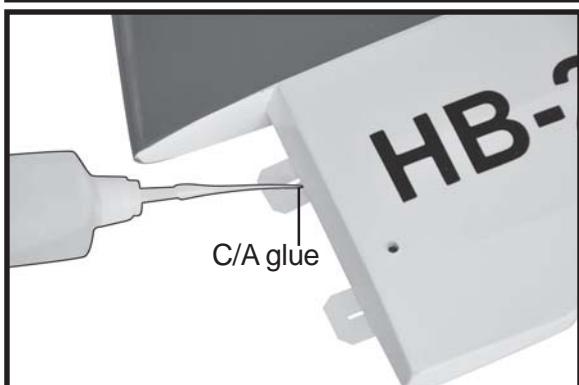
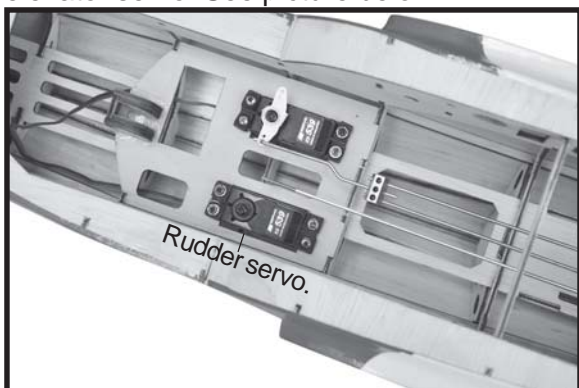

□ Using a modeling knife cut away the covering from the end of fuselage for the rudder hinge.

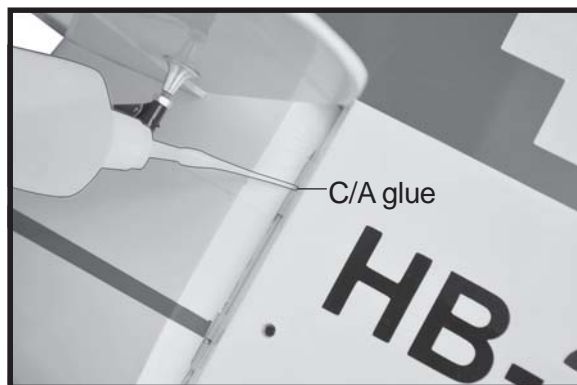
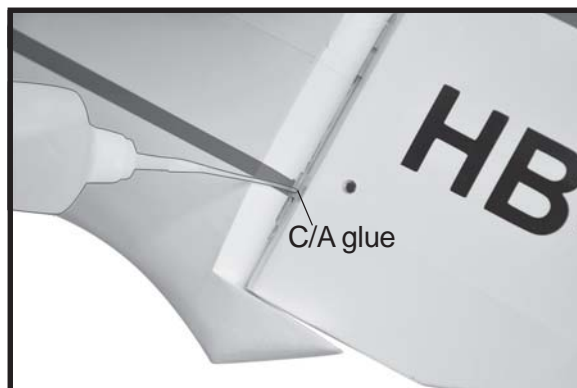
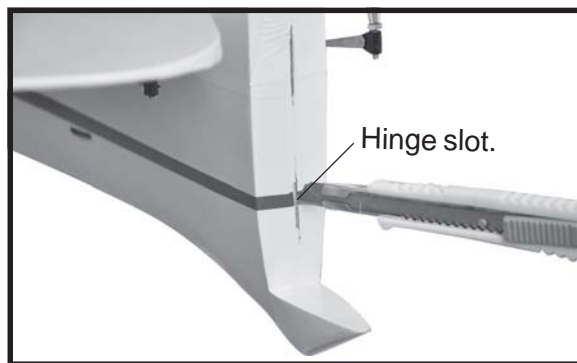
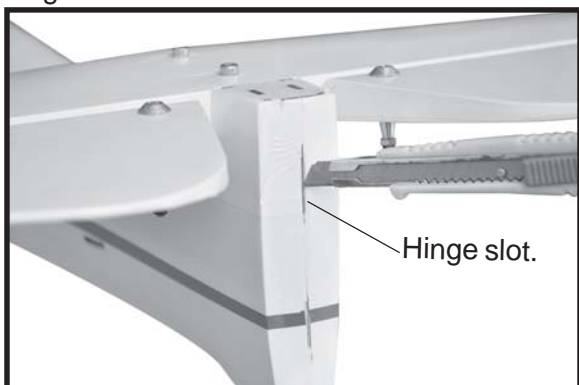

RUDDER CONTROL HORN INSTALLATION.

Rudder control horn install as same as the way of aileron control horn. Please see pictures below.

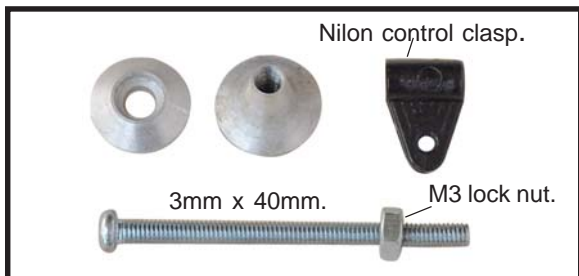

Control horn of Rudder.



RUDDER PUSHROD INSTALLATION.

Rudder pushrod install as same as the way of aileron pushrod.

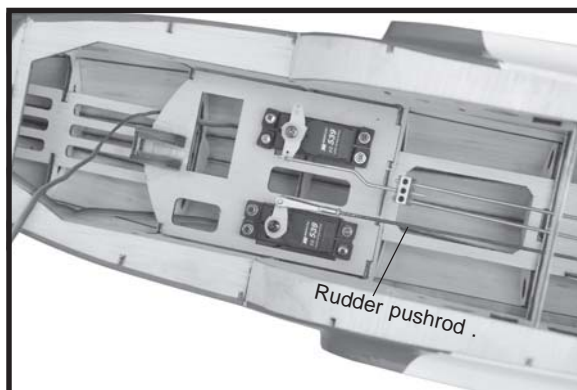
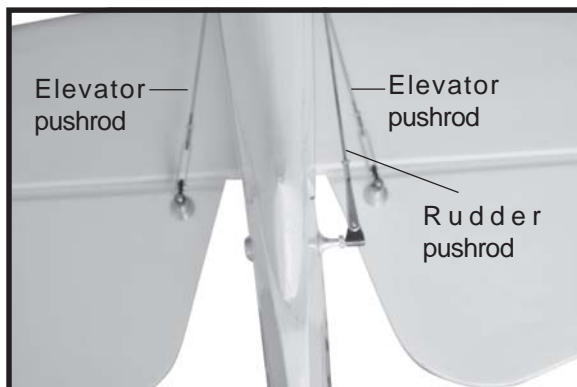

SERVO INSTALLATION.

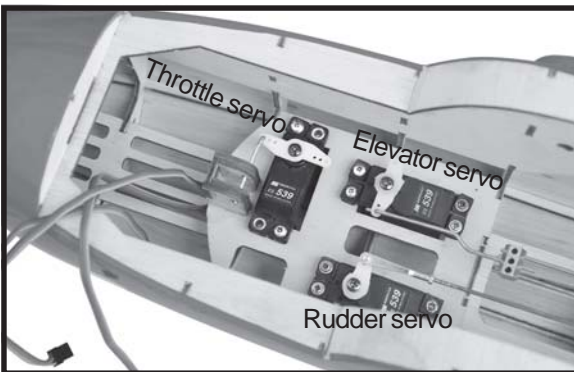

INSTALLING THE SWITCH.

□ 1) Cut out the switch hole using a modeling knife. Use a 2mm drill bit and drill out the two mounting holes through the fuselage side.

□ 2) Secure the switch in place using the two machine screws provided with the radio system.

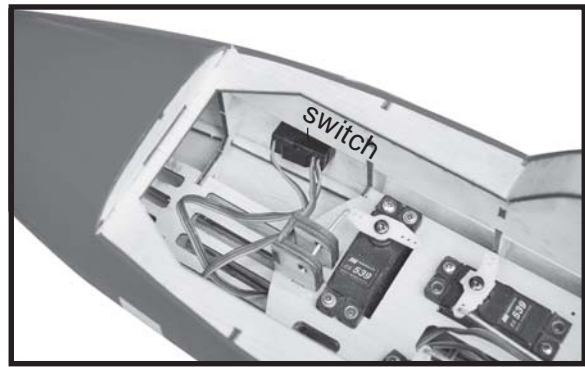
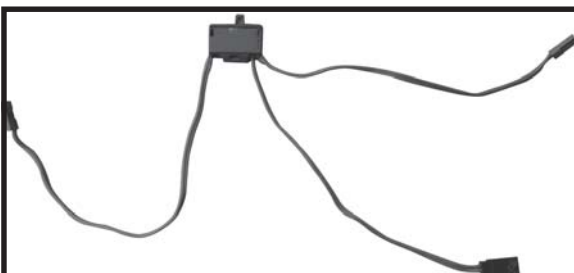

INSTALLING THE RECEIVER AND BATTERY.

□ 1. Plug the servo leads and the switch lead into the receiver. You may want to plug an aileron extension into the receiver to make plugging in the aileron servo lead easier when you are installing the wing. Plug the battery pack lead into the switch.

□ 2. Wrap the receiver and battery pack in the protective foam to protect them from vibration. Use a rubber band or masking tape to hold the foam in place.

□ 3. Position the battery pack and receiver behind the fuel tank. Use two tie wraps to hold the battery and receiver securely in place as pictures below

Do not permanently secure the receiver and battery until after balancing the model.

□ 4. Using a 2mm drill bit, drill a hole through the side of the fuselage, near the receiver, for the antenna to exit.

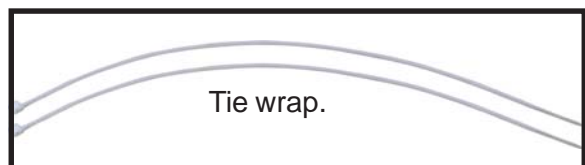

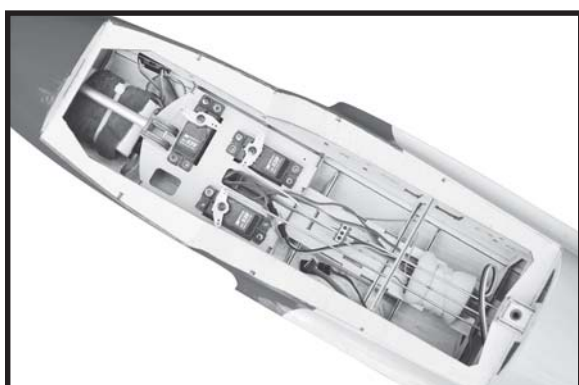
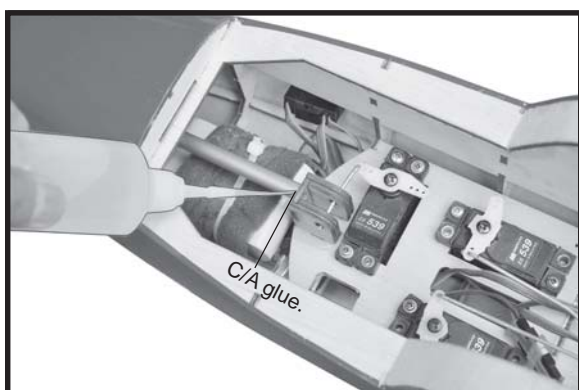
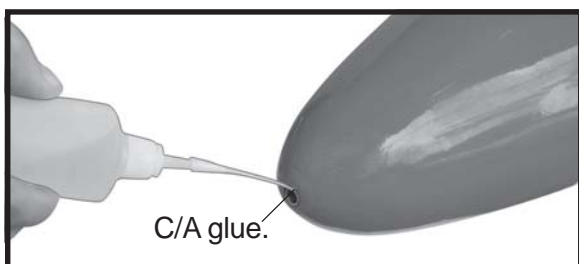
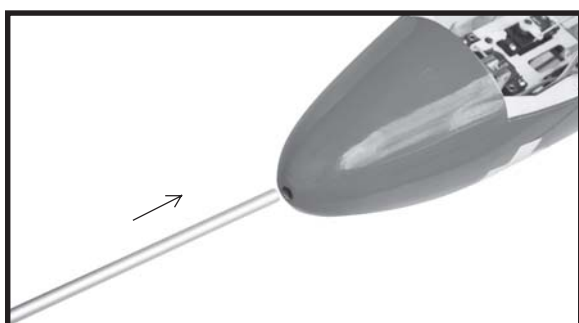
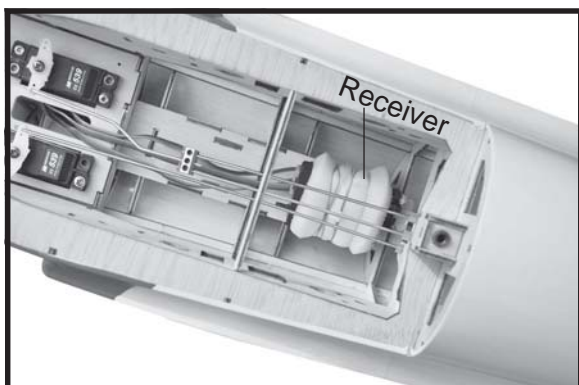

WING ATTACHMENT.

- ☐ Locate the carbon tube wing dihedral brace.



*** Test fit the carbon tube dihedral brace into each wing haft. The brace should slide in easily. If not, use 220 grit sand around the edges and ends of the brace until it fits properly.

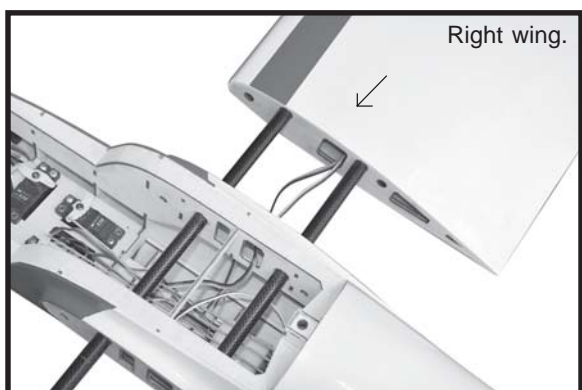
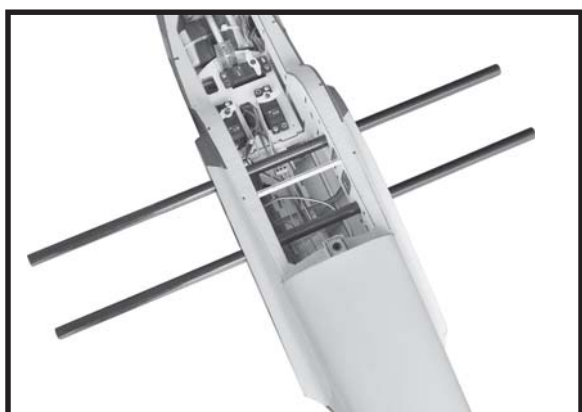

See picture wing attach to fuselage.



Wing bolt.

Installing the fuselage hatch as same as picture below.

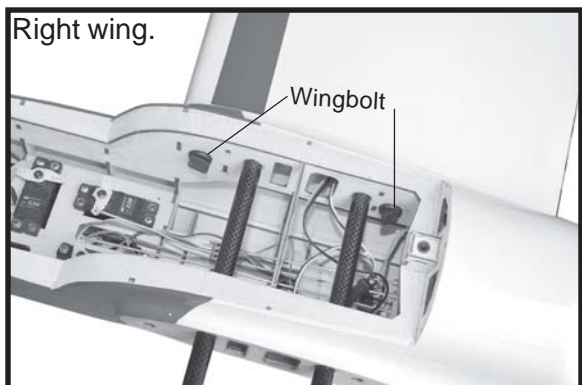

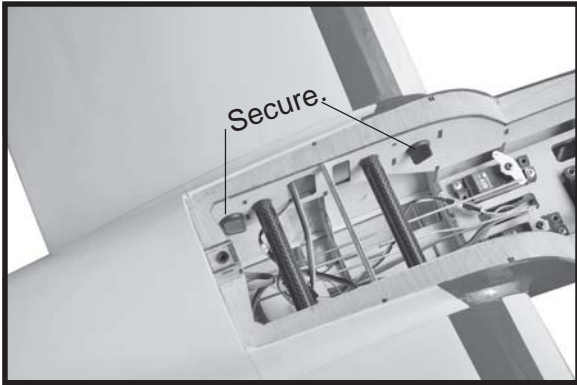
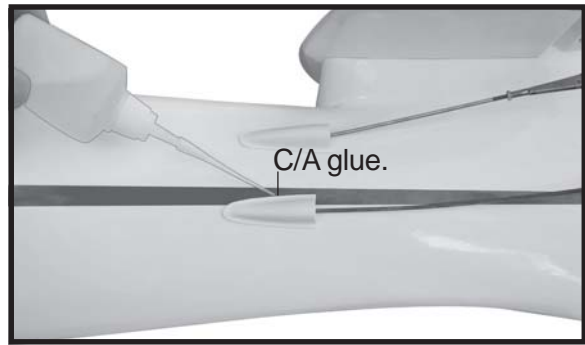
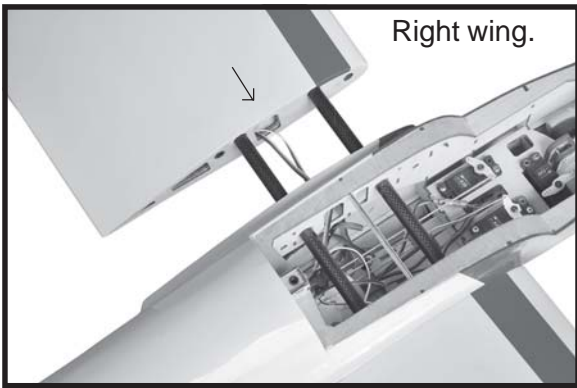

Plastic parts of rudder and elevator pushrod.

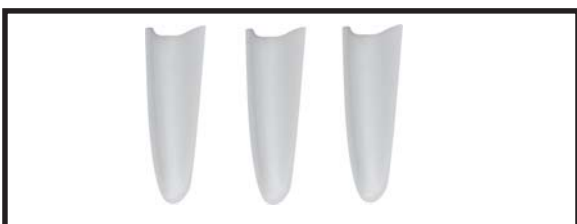
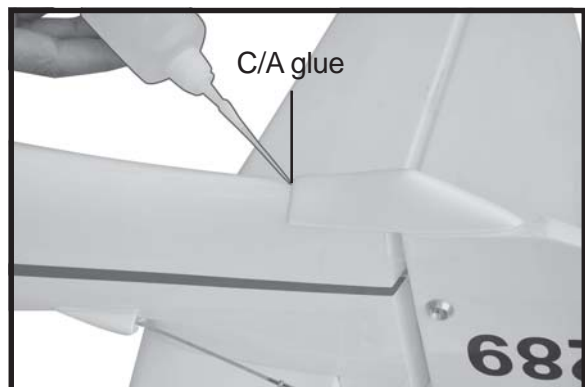
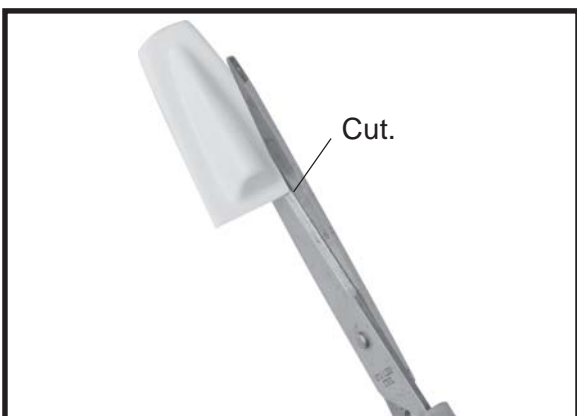

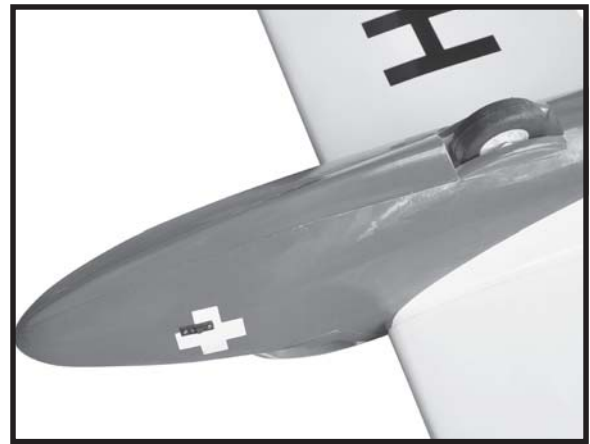
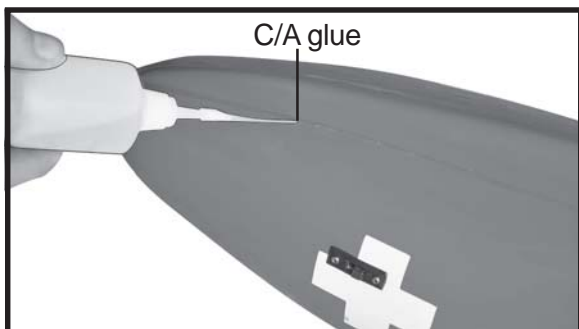
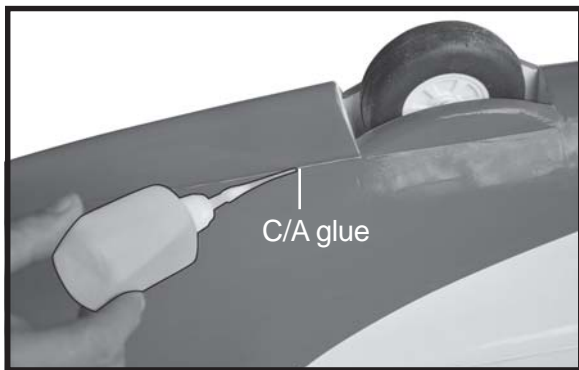
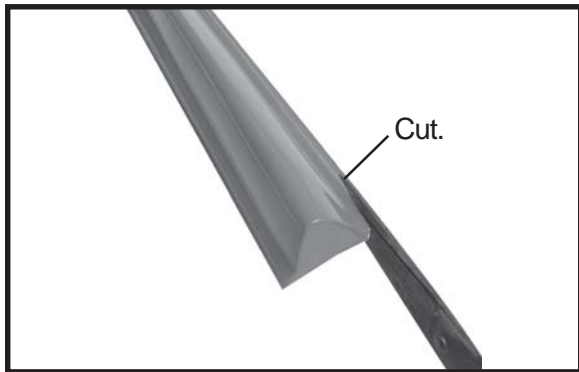

CANOPY AND PILOT.

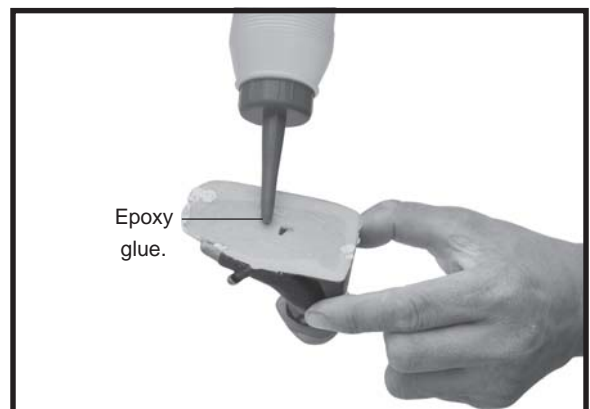
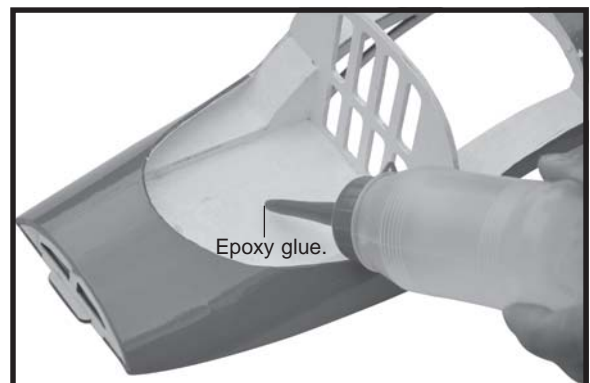

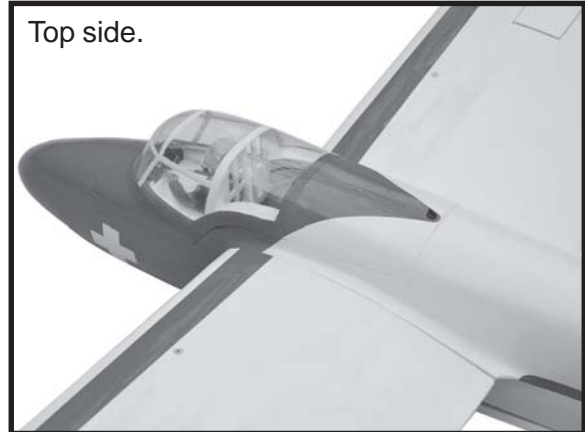
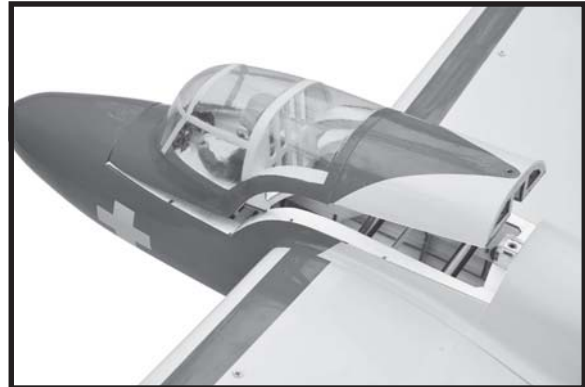
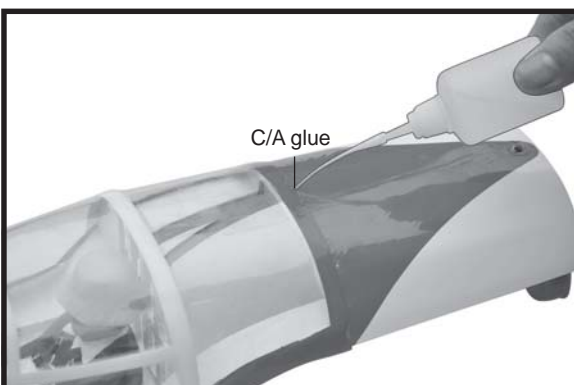
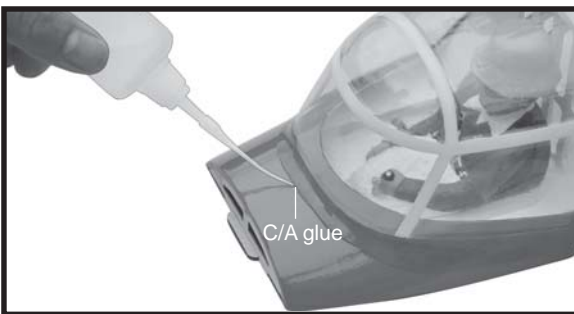
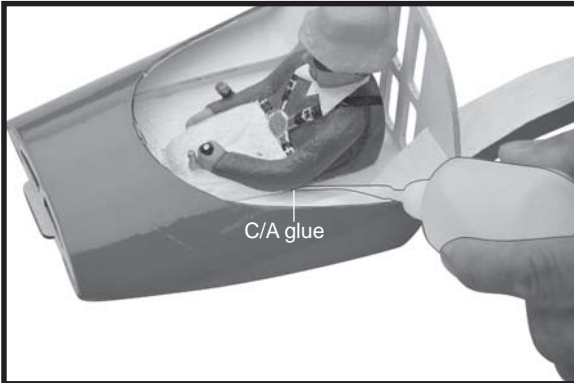

BALANCING.

□ 1) It is critical that your airplane be balanced correctly. Improper balance will cause your plane to lose control and crash.

THE CENTER OF GRAVITY IS LOCATED 110MM BACK FROM THE LEADING EDGE OF THE WING.

□ 2) Mount the wing to the fuselage. Using a couple of pieces of masking tape, place them on the top side of the wing 110 mm back from the leading edge, at the fuselage sides.

□ 3. Turn the airplane upside down. Place your fingers on the masking tape and carefully lift the plane .

Accurately mark the balance point on the top of the wing on both sides of the fuselage. The balance point is located 110mm back from the leading edge. This is the balance point at which your model should balance for your first flights. Later, you may wish to experiment by shifting the balance up to 10mm forward or back to change the flying characteristics. Moving the balance forward may improve the smoothness and arrow- like tracking, but it may then require more speed for take off and make it more difficult to slow down for landing. Moving the balance aft makes the model more agile with a lighter and snappier "feel". In any case, please start at the location we recommend .

With the wing attached to the fuselage, all parts of the model installed (ready to fly), and empty fuel tanks, hold the model at the marked balance point with the stabilizer level.

Lift the model. If the tail drops when you lift, the model is "tail heavy" and you must add weight* to the nose. If the nose drops, it is "nose heavy" and you must add weight* to the tail to balance.

*If possible, first attempt to balance the model by changing the position of the receiver battery and receiver. If you are unable to obtain good balance by doing so, then it will be necessary to add weight to the nose or tail to achieve the proper balance point.

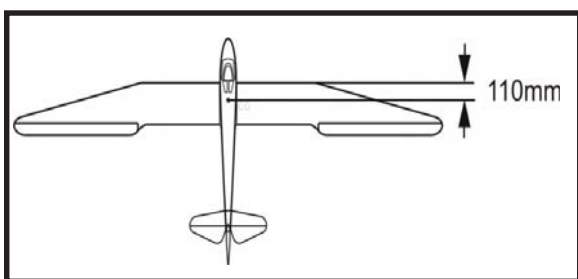

CONTROL THROWS.

- ▶ 1) We highly recommend setting up a plane using the control throws listed.
- ▶ 2) The control throws should be measured at the widest point of each control surface.
- ▶ 3) Check to be sure the control surfaces move in the correct directions.

Ailerons : 25mm up 25mm down
 Elevator : 25mm up 25 mm down
 Rudder : 45mm right 45mm left
 Flap : 30mm down

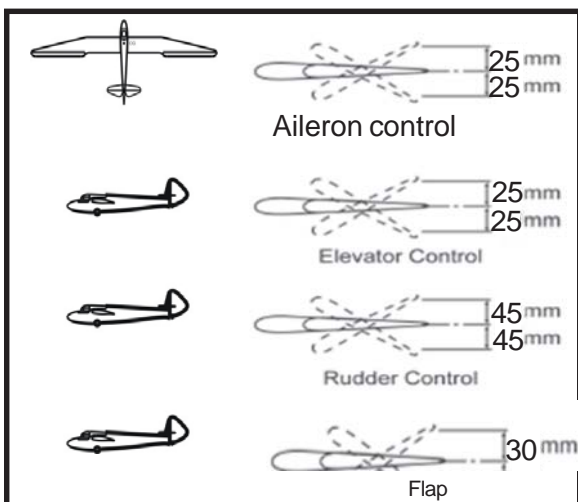

PRE-FLIGHT CHECK.

- ▶ 1) Completely charge your transmitter and receiver batteries before your first day of flying.
- ▶ 2) Check every bolt and every glue joint in your plane to ensure that everything is tight and well bonded.
- ▶ 3) Double check the balance of the airplane.
- ▶ 4) Check the control surface.
- ▶ 5) Check the receiver antenna . It should be fully extended and not coiled up inside the fuselage.
- ▶ 6) Properly balance the propeller.

We wish you many safe and enjoyable flights with your MINIMOA.

Accessories of wood box.

